

PART NUMBER	DESCRIPTION
21107-001	ASSEMBLY, SELF CONTAINED, AIR COOLED, 230/3/60, FM96AC (COOL ONLY)
21107-011	ASSEMBLY, SELF CONTAINED, AIR COOLED, 230/3/60, FM96AC (12KW HEAT)

FLAGSHIP MARINE, INC.				
REV.	ZONE	DESCRIPTION	DATE	ENG APPROVAL
01	-	INITIAL RELEASE	1/22/2018	-
02	-	ADDED STIFFENER TO DOOR	8/13/2018	-

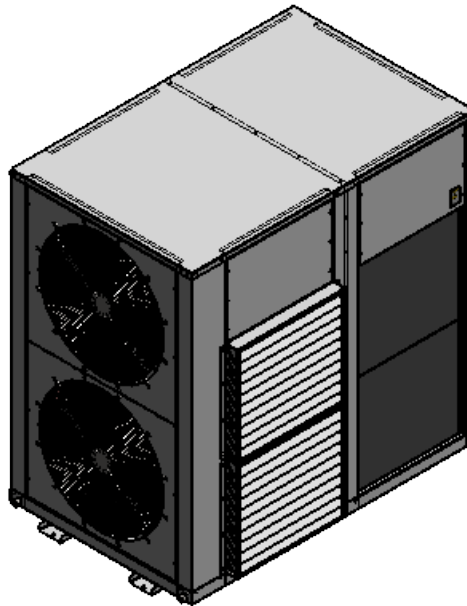
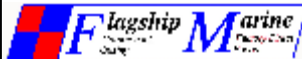

75	1	1	81166-001	WELDMENT, BASE, SELF CONTAINED, AIR COOLED, 1PH, FM120AC	38	8	8	60644-001	BOLT, 5/16"-18x1" HEX HEAD BOLT SS
74	1	1	80924-001	WELDMENT, PANEL, CONDENSING FAN, SELF CONTAINED, AIR COOLED, FM120AC	37	16	16	60643-001	WASHER, 5/16" USS FLAT, 18-8 SS
73	-	1	71569-001	FABRICATION, BRACKET, ENCLOSURE, LOW VOLTAGE, SELF CONTAINED, AIR COOLED, CHILLER UNIT, FM96/120AC	36	24	24	60636-001	WASHER, REGULAR FLAT TYPE B, #10 X .203"ID X .562"OD X .04"THK, 410 SS
72	2	2	71559-002	FABRICATION, FLUE, HEATING ELEMENTS, BLOWER, SELF CONTAINED, AIR COOLED, FM60AC	35	4	4	60539-001	NUT, 3/8-16 NYLON LOCK NUT 18-8 SS
71	1	1	71556-004	FABRICATION, JOIST, CONDENSING FAN, SELF CONTAINED, AIR COOLED, FM60AC	34	4	4	60534-001	WASHER, 3/8" X 1.25", FLAT
70	3	3	71556-003	FABRICATION, JOIST, CONTROL BOX, SELF CONTAINED, AIR COOLED, FM60AC	33	128	132	60531-001	RIVET, 3/16" DIA. .126-.250" GRIP RANGE TS, SS
69	4	4	71556-001	FABRICATION, JOIST, ACCESS UPPER, SELF CONTAINED, AIR COOLED, FM60AC	32	276	284	60527-001	SELF TAP, #8 X 1/2 HWH SELF DRILL 18-8 SS
68	1	1	71553-001	FABRICATION, LID, SELF CONTAINED, AIR COOLED, FM60AC	31	8	8	60515-001	NUT, 5/16-18, 18-8 SST, NYLON INSERT LOCKNUT
67	4	4	71101-001	FABRICATION, PANEL, FAN ENCLOSURE, SELF CONTAINED, AIR COOLED, FM120AC	30	1	2	60504-001	LABEL, CAUTION, HIGH VOLTAGE, 2.5" X 1.5"
66	1	1	71000-001	DETAIL, PLATE, SERIAL NUMBER TAG, FLAGSHIP MARINE	29	1	1	60500-001	LABEL, FMI MANUFACTURED BY
65	1	1	70997-001	TAG, LOW PRESSURE, ANODIZED, ETCHED	28	1	1	60471-001	LED, RED INDICATOR LIGHT, PRIMARY
64	1	1	70996-001	TAG, HIGH PRESSURE, ANODIZED, ETCHED	27	1	1	60347-001	COMPRESSOR, SCROLL, 230/3/60, 96K BTU AIR-COOLED UNITS, R22, ZR94
63	1	1	70992-001	TAG, HIGH PRESSURE FAULT, ANODIZED, ETCHED	26	2	2	60343-001	MOTOR, 1755 RPM, 2 HP, TEFC, 230/460/3/60, 7/8" SHAFT, BALDOR EM3558T
62	1	1	70984-001	TAG, POWER CONNECTIONS, ANODIZED, ETCHED	25	4	4	60294-001	EVAPORATOR, 28000 BTU, COPPER/ALUMINUM, 3-ROW, 8 FPI, 101X-3030
61	2	2	70954-003	FABRICATION, JOIST, SELF CONTAINED, AIR COOLED, FM120AC	24	4	4	60281-001	EVAPORATOR/CONDENSER, 49000 BTU, COPPER/ALUMINUM, 3-ROW, 16 FPI, 101X-3029
60	1	1	70954-002	FABRICATION, JOIST, SELF CONTAINED, AIR COOLED, FM120AC	23	2	2	60156-001	GRILL, 3/8" WIRE SPACE, 4" CNTR PLATE, 11ga (.120) SPIRAL, (8).187 SPOKES 304SS, MT HOLES #8
59	1	1	70954-001	FABRICATION, JOIST, SELF CONTAINED, AIR COOLED, FM120AC	22	2	2	60146-001	FAN, 6000CFM, 2HP, 22" DIAMETER, 1728 RPM, 37.5DEG. PITCH
58	1	1	70953-001	TAG, CONTROL CONNECTIONS, 24 V, ANODIZED, ETCHED	21	1	1	60140-001	GROMMET, SNAP-IN, FOR 1" OD PIPE
57	1	1	70899-001	FABRICATION, PANEL, BLOWER, UPPER, SELF CONTAINED, AIR COOLED, FM120AC	20	2	2	60131-001	GROMMET, 11/16" PUSH-IN LOCKING, NYLON
56	1	1	70898-001	FABRICATION, PANEL, CONTROL ENCLOSURE, SELF CONTAINED, AIR COOLED, FM120AC	19	-	2	60087-003	SWITCH, HEAT CONTROL, LEGEND PLATE, FOR 60086, ETCHED
55	1	1	70895-001	FABRICATION, PANEL, BLOWER, SELF CONTAINED, AIR COOLED, FM120AC	18	-	2	60086-001	SWITCH, LEGEND PLATE HOLDER
54	1	1	70894-001	FABRICATION, BRACKET, BLOWER, UPPER, SELF CONTAINED, AIR COOLED, FM120AC	17	-	2	60084-001	SWITCH, ON/OFF, W/ K10 CONTACTOR
53	1	1	70892-001	ASSEMBLY, PANEL, BIVECTOR, SELF CONTAINED, AIR COOLED, FM120AC	16	1	1	60082-001	FILTER, FILTER/DRIER, 7/8" ODF, C307S
52	1	1	70891-002	ASSEMBLY, PILLAR, BIVECTOR, SELF CONTAINED, AIR COOLED, FM120AC	15	20	20	60070-001	WASHER, .385 ID X 1.406 OD X .25 THK, 60 DURO EPDM BLACK
51	1	1	70891-001	ASSEMBLY, PILLAR, BIVECTOR, SELF CONTAINED, AIR COOLED, FM120AC	14	1	1	60069-001	SWITCH, PRESSURE, OPEN (400) CLOSE (300)
50	1	1	70890-001	ASSEMBLY, PILLAR, CORNER, BLOWER RIGHT, SELF CONTAINED, AIR COOLED, FM120AC	13	-	4	60062-001	SWITCH, THERMAL LIMIT, 130 DEG. F, NC
49	1	1	70889-001	ASSEMBLY, PILLAR, CORNER, BLOWER LEFT, SELF CONTAINED, AIR COOLED, FM120AC	12	-	4	60039-001	HEATER ELEMENT, COIL, 66"L, 8MM, 3000W, 240VAC, DBL END THRD BULKHEAD
48	1	1	70888-001	ASSEMBLY, PILLAR, CORNER, ELECTRICAL I/O, SELF CONTAINED, AIR COOLED, FM120AC	11	2	2	60014-001	BLOWER, PSC, FORWARD CURVE, DIRECT DRIVE, WHEEL DIA 13", DAYTON 1XJY4
47	1	1	70887-001	FABRICATION, PILLAR, CORNER, CHARGING PORTS, SELF CONTAINED, AIR COOLED, FM120AC	10	4	4	50041-001	DETAIL, .25" STANDOFF, MOTOR MOUNT, AIR HANDLER
46	2	2	70657-002	FABRICATION, STRAP, FILTER DRIER, CHILLER, FM360CW	9	2	2	40109-001	NUT, 1JLR4, SERVICE VALVE HI/LOW, BRN 1/2x1/8"
45	1	1	70170-001	DETAIL, PLATE, DECORATIVE, FLAGSHIP MARINE	8	2	2	40101-001	VALVE, THRU BHD FITTING, 1/4", SERVICE
44	A/R	A/R	61002-001	WEATHER STRIP, NEOPRENE/EPDM/SBR FOAM, ADHESIVE BACK, 3/16" THICK, 3/4" WIDE	7	1	1	40090-001	VALVE, EXPANSION, BALANCED PORT, 10-TON, R22, OVE-10-GA
43	A/R	A/R	61000-001	INSULATION, 1/8" FOAM PEEL AND STICK	6	A/R	A/R	30230-001	LOOM, SPLIT-TYPE, BLUE TRACER, 1/2", 1100', M125-0120-A
42	A/R	A/R	60998-001	TAPE, CORK ROLL, 30"x2"	5	2	2	30139-002	CONNECTOR, STRAIGHT, 1/2" PVC LIQUID TIGHT
41	1	1	60687-001	GROMMET, 1/2" DIA x 1/16" PANEL x 3/8" ID, SBR RUBBER	4	4	4	30139-001	CONNECTOR, 90 DEGREE PVC LIQUID-TIGHT, 1/2 NM TYPE B CONDUIT
40	50	50	60652-001	SCREW, #8-32 X 1" - #2 DRIVE TRUSS HEAD PHILLIPS, 18-8 SS	3	4	4	20800-002	ASSEMBLY, LOUVER PANEL, SELF CONTAINED, AIR COOLED, 36K BTU
39	59	59	60648-001	SCREW, #8-32 X 3/8" - #2 DRIVE TRUSS HEAD PHILLIPS, 316 SS	2	-	1	20156-002	CONTROL ENCLOSURE, SELF-CONTAINED, AIR COOLED, DUAL FANS, OPTIONAL HEAT, 230/460/3/60, (INSTALLED ON-BOARD UNIT)
					1	1	-	20156-001	CONTROL ENCLOSURE, SELF-CONTAINED, AIR COOLED, DUAL FANS, 230/460/3/60, (INSTALLED ON-BOARD UNIT)

ITEM NO.	QTY	001 QTY	011 QTY	PART NUMBER	DESCRIPTION	ITEM NO.	QTY	001 QTY	011 QTY	PART NUMBER	DESCRIPTION																		
<p>FLAGSHIP MARINE, INC. BILL OF MATERIALS</p> <div style="display: flex; justify-content: space-between;"> <div style="width: 45%;">  <p>FLAGSHIP MARINE, INC. 2427 SE DIXIE HIGHWAY STUART FLORIDA 34996 USA (772) 283-1609 (800) 316-6426 FAX (772) 283-4611</p> <p>PROPRIETARY AND CONFIDENTIAL</p> <p>THIS DOCUMENT CONTAINS INFORMATION PROPRIETARY TO FLAGSHIP MARINE, INC. NO PART MAY BE REPRODUCED, USED IN ANY FORM, OR STORED ELECTRONICALLY WITHOUT THE WRITTEN PERMISSION OF FLAGSHIP MARINE, INC.</p> </div> <div style="width: 45%;"> <p>UNLESS OTHERWISE SPECIFIED: DIMENSIONS ARE IN INCHES TOLERANCES: FRACTIONS ± 1/32 ANG: MACH ± 0°30' BEND ± 2° DECIMALS .XX ± .01 .XXX ± .005 HOLE Ø .XX ± .005</p> <p>INTERPRET GEOMETRIC TOLERANCING PER: ASME Y14.5M</p> <p>MATERIAL</p> <p>FINISH</p> <p>PERP STRAIGHTNESS ± .003/IN FLATNESS ± .005/IN THREADS: EXTERNAL - CLASS 2A INTERNAL - CLASS 2B MACHINED SURFACES: ✓ U.O.S</p> </div> </div>																													
<p>FLAGSHIP MARINE, INC. BILL OF MATERIALS</p> <table border="1" style="width: 100%;"> <thead> <tr> <th>NAME</th> <th>DATE</th> <th>TITLE:</th> </tr> </thead> <tbody> <tr> <td>DRAWN</td> <td>TJW</td> <td>2/20/2017</td> </tr> <tr> <td>CHECKED</td> <td>TCM</td> <td>-</td> </tr> <tr> <td>ENG APPR.</td> <td>TCM</td> <td>-</td> </tr> <tr> <td>MFG APPR.</td> <td>TCM</td> <td>-</td> </tr> <tr> <td>Q.A.</td> <td>EAS</td> <td>-</td> </tr> </tbody> </table> <p>TITLE: ASSEMBLY, SELF CONTAINED, AIR COOLED, FM96AC</p> <p>PART NO.: 21107-0XX</p> <p>SIZE: B DWG. NO.: FM21107 REV: 02</p> <p>NSN NO.: -</p> <p>SCALE: 1:20 WGT: 772.62 LBS SHEET 1 OF 2</p>												NAME	DATE	TITLE:	DRAWN	TJW	2/20/2017	CHECKED	TCM	-	ENG APPR.	TCM	-	MFG APPR.	TCM	-	Q.A.	EAS	-
NAME	DATE	TITLE:																											
DRAWN	TJW	2/20/2017																											
CHECKED	TCM	-																											
ENG APPR.	TCM	-																											
MFG APPR.	TCM	-																											
Q.A.	EAS	-																											

3. REMOVE ALL BURRS & BREAK SHARP EDGES .005" MAX.
2. PREFERRED LIMITS AND FITS PER ANSI B4.1 (INCHES).
1. DIMENSIONING & TOLERANCING PER ASME Y14.5M.

NOTES:

APPLICATION DO NOT SCALE DRAWING

8 7 6 5 4 2 1

D
C
B
A

D
C
B
A

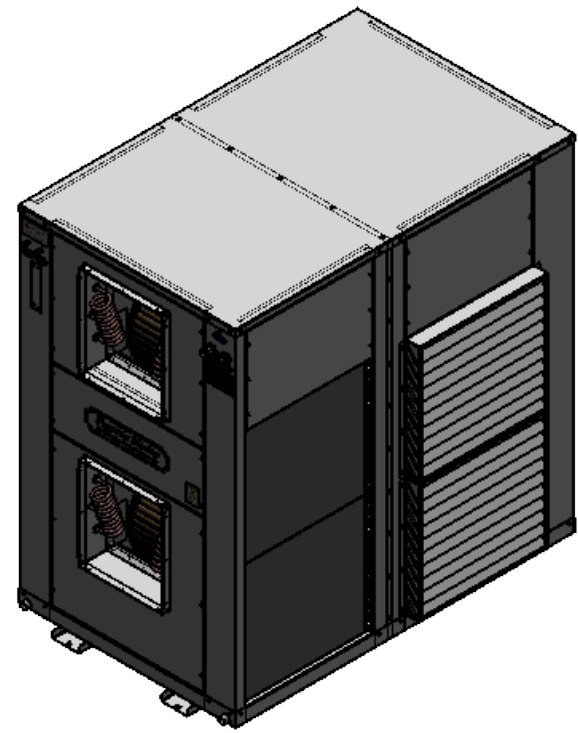

**21107-011
SHOWN**

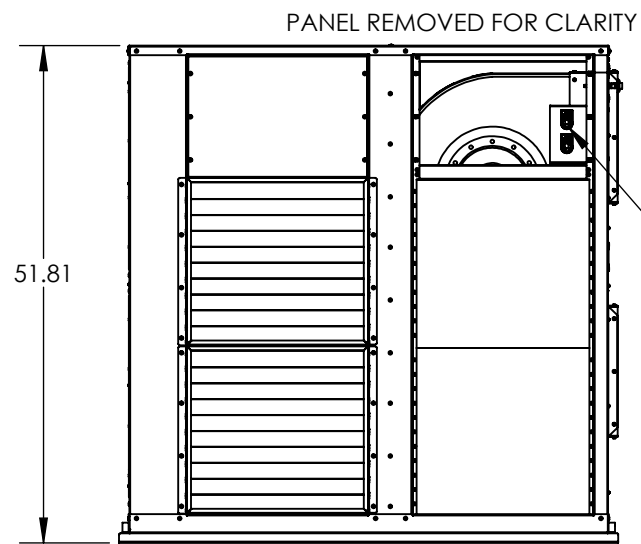
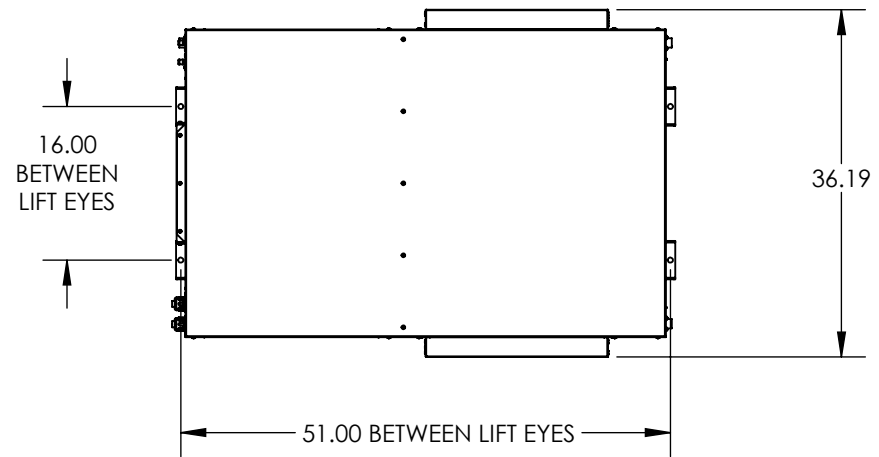

PANEL REMOVED FOR CLARITY

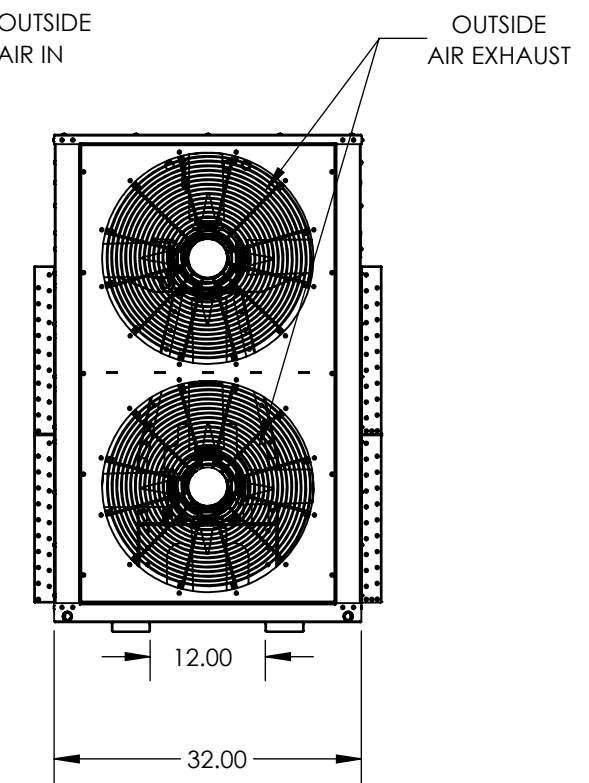
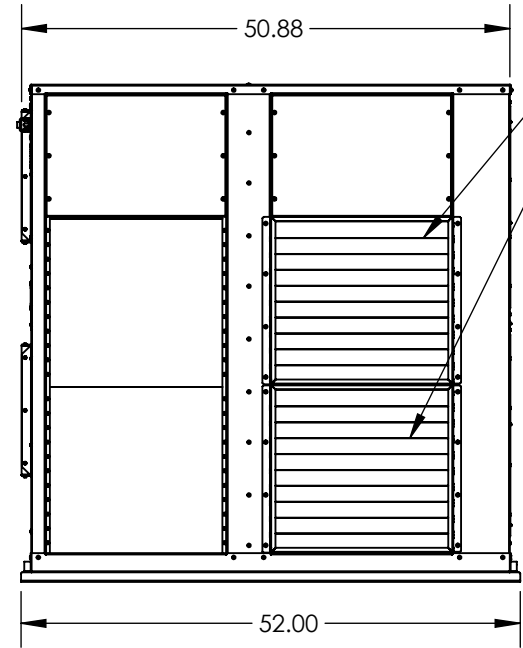
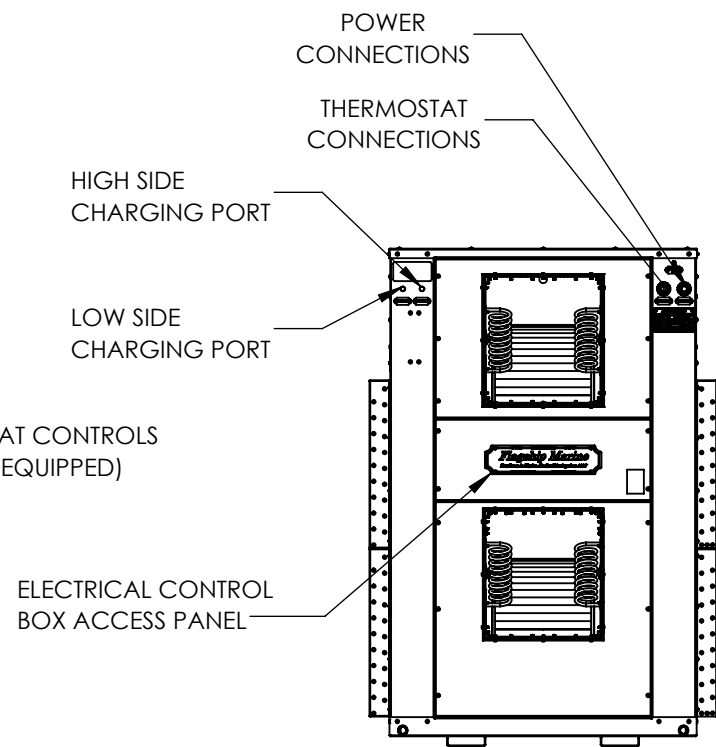

Flagship Marine
COMMERCIAL QUALITY FRESHWATER MARINE

2427 SE DIXIE HIGHWAY | STUART | FLORIDA | 34996 | USA
(772) 283-1609 | (800) 316-6426 FAX (772) 283-4611

DRAWN -	SIZE B	DRAWING NO. FM21107	REV 02
CHECKED -	WGT: 772.62 LBS	SCALE: 1:20	SHEET 2 OF 2
ENG APPR. -			

8 7 6 5 4 3 2 1